

GRU A MONTAGGIO RAPIDO
 GRUE A MONTAGE RAPIDE
 GRUA DE RAPIDO MONTAJE
 GRUA DE MONTAGEM RAPIDA
 QUICK SELFERECTING CRANE
 HYDRAULISCHER SCHNELLMONTAGEKRAN

Curve di carico – Courbes de charges – Load diagrams – LastKurven – Curvas de cargas

	<table border="1"> <tr> <td>3</td> <td>23</td> <td>27,3</td> <td>m</td> </tr> <tr> <td>700</td> <td>700</td> <td>700</td> <td>kg</td> </tr> </table>	3	23	27,3	m	700	700	700	kg								
3	23	27,3	m														
700	700	700	kg														
	<table border="1"> <tr> <td>3</td> <td>11,7</td> <td>12</td> <td>16</td> <td>20</td> <td>24</td> <td>28</td> <td>m</td> </tr> <tr> <td>2400</td> <td>2400</td> <td>2310</td> <td>1610</td> <td>1220</td> <td>970</td> <td>800</td> <td>kg</td> </tr> </table>	3	11,7	12	16	20	24	28	m	2400	2400	2310	1610	1220	970	800	kg
3	11,7	12	16	20	24	28	m										
2400	2400	2310	1610	1220	970	800	kg										
	<table border="1"> <tr> <td>3</td> <td>12,7</td> <td>16</td> <td>20</td> <td>23</td> <td></td> <td></td> <td>m</td> </tr> <tr> <td>2400</td> <td>2400</td> <td>1810</td> <td>1375</td> <td>1100</td> <td></td> <td></td> <td>kg</td> </tr> </table>	3	12,7	16	20	23			m	2400	2400	1810	1375	1100			kg
3	12,7	16	20	23			m										
2400	2400	1810	1375	1100			kg										
	<table border="1"> <tr> <td>3</td> <td>13,3</td> <td>m</td> </tr> <tr> <td>2400</td> <td>2400</td> <td>kg</td> </tr> </table>	3	13,3	m	2400	2400	kg										
3	13,3	m															
2400	2400	kg															

Reazioni – Reactions – Réactions – Eckdrücke – Reacciones

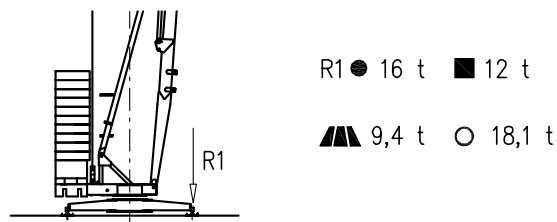

- | | | |
|-------------------------------|---------------------------------------|--------------------------------------|
| ● Reazioni in servizio | ● Reactions in service | ● Réactions en service |
| ■ Reazioni fuori servizio | ■ Reactions out of service | ■ Réactions hors service |
| ▲ Peso della gru senza assali | ▲ Dead weight without transport axles | ▲ Poids de construction sans essieux |
| ○ Peso zavorra rotante | ○ Ballast weight | ○ Poids du lest |
-
- | | | |
|--|--|---|
| ● Reaktionskräfte in betrieb | ● Reacciones en servicio | ● Em serviço |
| ■ Reaktionskräfte außer betrieb | ■ Reacciones fuera de servicio | ■ Fora de serviço |
| ▲ Konstruktionsgewicht ohne transportachse | ▲ Peso de la grua sin tren de transporte | ▲ Peso de la grua sem carro de transporte |
| ○ Ballastgewicht | ○ Peso de lastre | ○ Peso de lastre rotativo |

Montaggio – Montage – Erection – Montage – Montaje

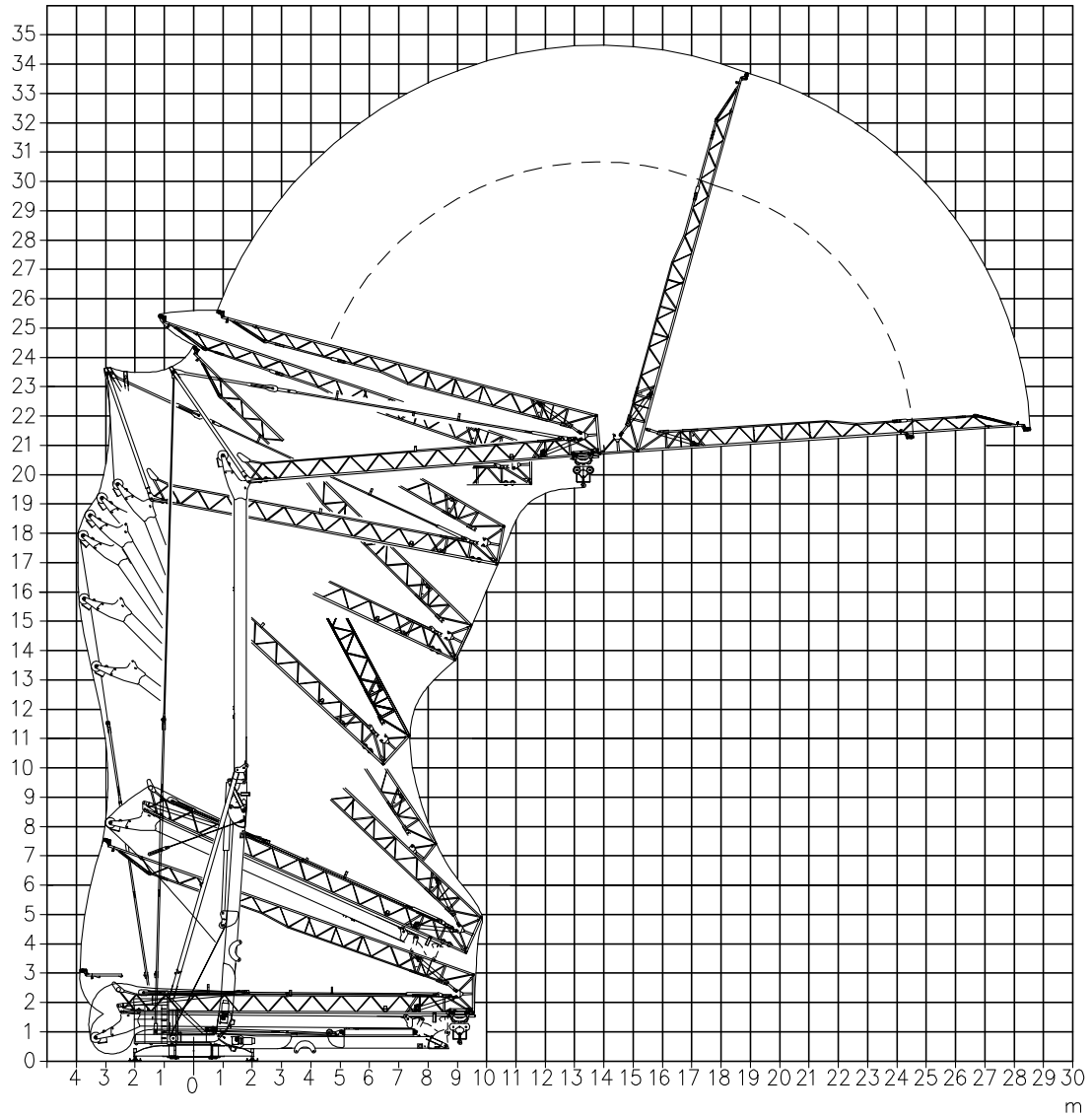



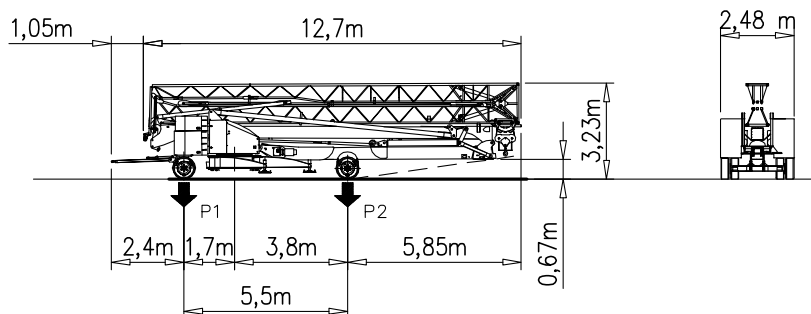

Trasporto – Transport – Transport – Transport – Transporte

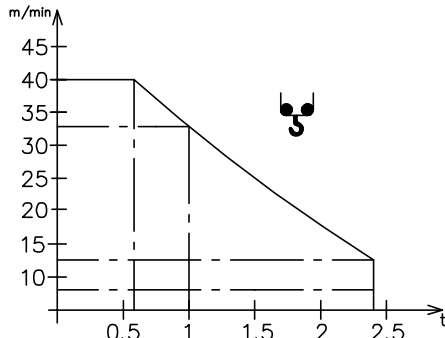
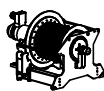

P1	Kg	7650
P2	Kg	8130
Ptot	Kg	15780

Meccanismi – Mechanisms – Mécanismes – Antriebe – Mecanismos

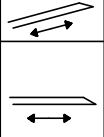
V9.32 Sollevamento Hoisting Levage Heben Elevaciòn Elevaçao							V9.32 6.6 kW (9 Hp) 17.5 kVA 
	m/min	4	13	32	40		
	t	2.4	2.4	1.0	0.6		

Carrello Trolleying Distribuciòn			2a	0 → 30	m/min	2.2 kW (Hp 3)
			1a			
Rotazione Slewing Orientaciòn			1a	0 → 0.8	giri/min tr/min rp/min	2.2 kW (Hp 3)
			2a			
			3a			

Rete elettrica – Réseau – Mains supply – Netzstrom – Red	400V – 50 Hz
--	--------------

Potenza elettrica necessaria – Puissance électrique nécessaire Necessary electric power – Anschlusswert – Potencia electrica necesaria	17,5 kVA
---	----------

AFM Gru FMgru s.r.l.
 via Emilia 11-29010 Pontenure PC ITALY
 tel. 0523/510446 ric.aut. fax 0523/510365
 www.fmgru.it e-mail: info@fmgru.com

FEM 1.001-A3
2000/14/CE



Documento commerciale non contrattuale
Per tutte le informazioni tecniche riferirsi
alle corrispondenti istruzioni

Unverbindliches Vertriebsdokument.
Für technische Informationen, siehe die
entsprechenden Anweisungen.

This commercial document is not legally
binding. For any technical information, please
refer to the corresponding instructions.

Documento comercial non contractual
Para cualquier información técnica,
ver la noticia correspondiente.

Code: 15CA37B45A0			
Ed.	Data	Rev	Data
1	18.09.06	1	18.03.10